

瓷

EYELET

眼

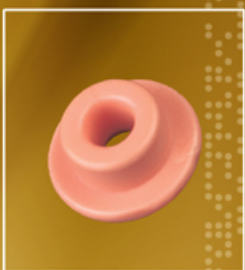

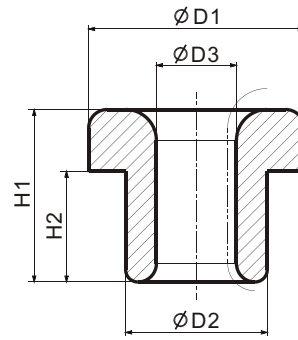
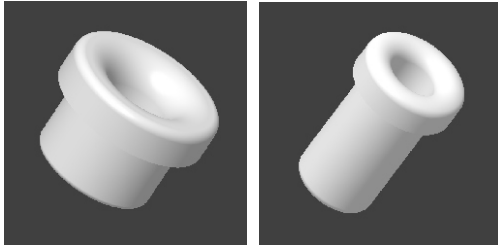

| Part No | D1 | D2 | D3 | H1 | H2 |
|--------------|------|------|------|------|------|
| TCA001A1PKNP | 2.30 | 1.80 | 1.00 | 7.0 | 5.0 |
| TCA002A1PKNP | 3.10 | 1.80 | 1.00 | 2.4 | 1.4 |
| TCA003A1PKNP | 3.20 | 2.00 | 1.00 | 8.0 | 7.0 |
| TCA004A1PKNP | 3.10 | 2.00 | 1.00 | 3.0 | 2.0 |
| TCA005T1BKNP | 3.10 | 2.00 | 1.10 | 6.0 | 5.0 |
| TCA006A1PKNP | 2.60 | 2.10 | 0.90 | 11.5 | 10.5 |
| TCA007A1RDNP | 3.40 | 2.20 | 1.20 | 2.3 | 1.6 |
| TCA008A1GPNP | 3.00 | 2.30 | 1.30 | 7.1 | 6.1 |
| TCA009A1WTNP | 3.50 | 2.30 | 1.30 | 2.8 | 1.8 |
| TCA010A1GPNP | 3.80 | 2.50 | 1.40 | 8.3 | 7.0 |
| TCA011A1GPNP | 3.80 | 2.50 | 1.40 | 6.8 | 5.5 |
| TCA012A1GPNP | 3.80 | 2.50 | 1.50 | 5.0 | 4.0 |
| TCA013A1PKNP | 3.80 | 2.50 | 1.30 | 6.8 | 5.5 |
| TCA014A1PKNP | 3.80 | 2.50 | 1.50 | 8.8 | 8.0 |
| TCA015A1PKNP | 5.00 | 2.50 | 1.00 | 3.8 | 2.8 |
| TCA016A1PKNP | 3.80 | 2.50 | 1.50 | 4.0 | 3.0 |
| TCA017A1PKNP | 3.80 | 2.50 | 1.50 | 3.0 | 2.0 |
| TCA018A1PKNP | 3.00 | 2.50 | 1.50 | 2.5 | 1.5 |
| TCA019A1PKNP | 3.80 | 2.50 | 1.50 | 4.5 | 3.4 |
| TCA020T1BKNP | 3.80 | 2.50 | 1.40 | 8.3 | 7.0 |
| TCA021T1BKNP | 3.80 | 2.50 | 1.50 | 6.9 | 5.5 |
| TCA022T1BKNP | 3.80 | 2.50 | 1.30 | 6.8 | 5.5 |
| TCA023T1BKNP | 3.50 | 2.50 | 1.20 | 5.0 | 4.0 |
| TCA024T1BKNP | 3.50 | 2.50 | 1.20 | 6.0 | 5.0 |
| TCA025T1BKNP | 3.80 | 2.50 | 1.40 | 6.8 | 5.5 |
| TCA026T1BKNP | 3.80 | 2.50 | 1.40 | 8.4 | 7.0 |
| TCA027A1PKNP | 4.60 | 2.60 | 1.30 | 4.0 | 3.0 |
| TCA028A1WTNP | 4.50 | 2.70 | 1.15 | 3.0 | 2.0 |
| TCA029A1PKNP | 3.80 | 2.70 | 1.50 | 4.0 | 3.0 |
| TCA030A1RDNP | 4.30 | 2.70 | 1.60 | 3.4 | 2.4 |
| TCA031T1BKNP | 4.60 | 2.70 | 1.40 | 11.0 | 9.5 |
| TCA032A1PKNP | 4.00 | 2.80 | 1.00 | 4.2 | 3.0 |
| TCA033A1PKNP | 4.80 | 2.80 | 1.20 | 3.2 | 2.0 |
| TCA034A1PKNP | 4.80 | 2.80 | 1.20 | 4.2 | 3.0 |
| TCA035T1BKNP | 4.80 | 2.80 | 1.20 | 4.2 | 3.0 |
| TCA036A1RDNP | 4.50 | 2.85 | 1.60 | 4.5 | 3.5 |
| TCA037T1BKNP | 4.90 | 2.90 | 1.50 | 4.0 | 3.0 |

| Part No | D1 | D2 | D3 | H1 | H2 |
|--------------|------|------|------|-----|-----|
| TCA038T1BKNP | 4.90 | 2.90 | 1.50 | 3.0 | 2.0 |
| TCA039T1BKNP | 4.80 | 2.95 | 1.50 | 4.0 | 3.0 |
| TCA040A1RDNP | 4.00 | 3.00 | 1.50 | 3.0 | 2.0 |
| TCA041A1GPNP | 4.20 | 3.00 | 1.70 | 4.2 | 3.0 |
| TCA042A1PKNP | 4.20 | 3.00 | 2.00 | 3.8 | 3.0 |
| TCA043A1PKNP | 4.20 | 3.00 | 2.00 | 4.8 | 4.0 |
| TCA044A1PKNP | 4.90 | 3.00 | 1.55 | 3.2 | 2.2 |
| TCA045A1PKNP | 4.00 | 3.00 | 1.60 | 8.5 | 7.0 |
| TCA046A1GPNP | 4.00 | 3.00 | 1.80 | 5.2 | 4.0 |
| TCA047A1PKNP | 4.50 | 3.00 | 1.80 | 8.2 | 7.0 |
| TCA048A1GPNP | 4.10 | 3.00 | 1.70 | 4.1 | 2.0 |
| TCA049A1PKNP | 4.00 | 3.00 | 1.50 | 6.2 | 5.0 |
| TCA050A1PKNP | 4.00 | 3.00 | 1.50 | 7.2 | 6.0 |
| TCA051A1GPNP | 4.00 | 3.00 | 1.60 | 5.2 | 4.2 |
| TCA052A1GPNP | 4.00 | 3.00 | 1.80 | 5.2 | 3.0 |
| TCA053A1GPNP | 4.00 | 3.00 | 1.80 | 6.2 | 4.0 |
| TCA054T1BKNP | 4.80 | 3.00 | 1.50 | 3.2 | 2.1 |
| TCA055T1BKNP | 5.00 | 3.00 | 1.50 | 3.3 | 2.0 |
| TCA056T1BKNP | 4.20 | 3.00 | 1.60 | 2.0 | 1.0 |
| TCA057T1BKNP | 5.00 | 3.00 | 1.40 | 4.0 | 3.0 |
| TCA058T1BKNP | 4.30 | 3.00 | 1.60 | 4.3 | 3.0 |
| TCA059T1BKNP | 4.20 | 3.00 | 1.60 | 3.0 | 2.0 |
| TCA060T1BKNP | 5.00 | 3.00 | 1.50 | 2.3 | 1.0 |
| TCA061T1YWNP | 5.10 | 3.00 | 1.50 | 3.3 | 2.2 |
| TCA062T1BKNP | 4.20 | 3.00 | 1.70 | 2.0 | 1.0 |
| TCA063T1BKNP | 3.80 | 3.00 | 1.60 | 5.0 | 4.0 |
| TCA064A1GPNP | 5.00 | 3.10 | 1.90 | 4.0 | 3.0 |
| TCA065A1GPNP | 5.00 | 3.10 | 1.60 | 4.0 | 2.8 |
| TCA066A1PKNP | 5.00 | 3.10 | 1.90 | 5.0 | 4.0 |
| TCA067A1GPNP | 4.00 | 3.10 | 1.70 | 2.1 | 1.0 |
| TCA068T1BKNP | 4.20 | 3.10 | 1.70 | 4.2 | 3.1 |
| TCA069T1BKNP | 4.20 | 3.10 | 1.70 | 3.0 | 2.1 |
| TCA070A1PKNP | 5.60 | 3.20 | 1.60 | 4.7 | 3.5 |
| TCA071A1PKNP | 4.00 | 3.20 | 1.40 | 2.7 | 1.5 |
| TCA072A1PKNP | 5.00 | 3.20 | 1.80 | 4.0 | 2.7 |
| TCA073T1BKNP | 4.90 | 3.25 | 1.40 | 5.0 | 3.8 |
| TCA074A1PKNP | 4.50 | 3.30 | 2.00 | 4.0 | 3.0 |

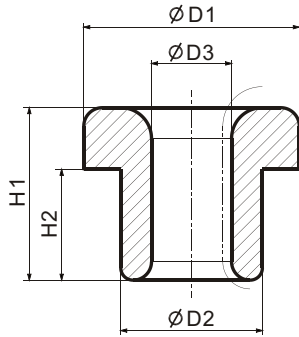

| Part No | D1 | D2 | D3 | H1 | H2 |
|---------------|------|------|------|-----|-----|
| TCA075A1PKNP | 4.10 | 3.30 | 2.20 | 4.3 | 3.4 |
| TCA076T1BKNP | 4.70 | 3.30 | 1.60 | 3.1 | 2.1 |
| TCA077A1RDNP | 4.50 | 3.40 | 1.80 | 3.5 | 2.5 |
| TCA078A1RDNP | 4.40 | 3.40 | 2.45 | 3.5 | 2.5 |
| TCA079A1WTNP | 5.00 | 3.50 | 1.70 | 3.3 | 2.2 |
| TCA080A1PKNP | 5.00 | 3.50 | 2.40 | 3.6 | 2.6 |
| TCA081A1PKNP | 4.70 | 3.70 | 2.00 | 6.6 | 5.0 |
| TCA082A1WTNP | 4.80 | 3.70 | 1.90 | 6.6 | 4.9 |
| TCA083A1PKNP | 5.00 | 3.80 | 2.00 | 4.0 | 3.0 |
| TCA084A1RDNP | 7.00 | 3.80 | 1.70 | 4.2 | 2.7 |
| TCA085A1PKNP | 7.00 | 3.80 | 2.00 | 4.5 | 2.6 |
| TCA086A1RDNP | 5.35 | 3.80 | 1.90 | 3.1 | 2.1 |
| TCA087A1PKNP | 5.60 | 3.80 | 1.90 | 5.2 | 4.0 |
| TCA088A1RDNP | 5.40 | 3.80 | 2.10 | 3.1 | 2.1 |
| TCA089T1BKNP | 7.00 | 3.80 | 1.90 | 3.9 | 2.3 |
| TCA090T1BKNP | 6.90 | 3.80 | 2.30 | 3.8 | 2.5 |
| TCA091A1GPNP | 5.50 | 3.90 | 1.90 | 4.3 | 3.0 |
| TCA092A1PKNP | 5.00 | 3.90 | 1.50 | 6.5 | 5.0 |
| TCA093A1WTNP | 5.50 | 3.90 | 2.20 | 8.8 | 7.2 |
| TCA094T1BKNP | 5.70 | 3.90 | 2.40 | 3.3 | 2.4 |
| TCA095A1WTNP | 5.00 | 4.00 | 2.70 | 4.0 | 3.0 |
| TCA096A1RDNP | 5.30 | 4.00 | 2.00 | 3.2 | 2.2 |
| TCA097A1RDNP | 5.50 | 4.00 | 1.90 | 3.0 | 2.0 |
| TCA098A1WTNP | 6.20 | 4.00 | 2.00 | 4.6 | 3.0 |
| TCA099A1PKNP | 5.00 | 4.00 | 2.70 | 5.0 | 4.0 |
| TCA100A1WTNP | 6.20 | 4.00 | 1.80 | 4.6 | 3.0 |
| TCA101A1PKNP | 6.20 | 4.00 | 1.80 | 3.0 | 2.0 |
| TCA102A1WTNP | 6.20 | 4.00 | 2.00 | 5.6 | 4.5 |
| TCA103A1GPNP | 5.00 | 4.00 | 2.50 | 5.0 | 4.0 |
| TCA104A1WTNPP | 5.00 | 4.00 | 2.50 | 4.0 | 2.5 |
| TCA105A1GPNP | 5.00 | 4.00 | 2.70 | 5.0 | 4.0 |
| TCA106A1WTNP | 5.00 | 4.00 | 2.70 | 5.5 | 4.0 |
| TCA107A1PKNP | 5.50 | 4.00 | 2.00 | 6.5 | 5.0 |
| TCA108A1GPNP | 5.50 | 4.00 | 2.50 | 3.5 | 2.0 |
| TCA109A1PKNP | 6.30 | 4.00 | 2.00 | 5.0 | 3.2 |
| TCA110A1PKNP | 5.00 | 4.00 | 2.80 | 4.0 | 3.0 |
| TCA111A1RDNP | 6.00 | 4.00 | 2.00 | 5.0 | 3.5 |
| TCA112T1BKNP | 7.00 | 4.00 | 1.50 | 4.2 | 2.6 |
| TCA113T1BKNP | 7.20 | 4.00 | 1.40 | 4.3 | 2.6 |
| TCA114A1RDNP | 4.80 | 4.05 | 2.90 | 2.5 | 2.0 |

| Part No | D1 | D2 | D3 | H1 | H2 |
|--------------|------|------|------|------|------|
| TCA115A1PKNP | 5.40 | 4.05 | 2.50 | 3.4 | 2.3 |
| TCA116T1BKNP | 5.40 | 4.05 | 2.50 | 3.4 | 2.3 |
| TCA117A1PKNP | 5.00 | 4.10 | 2.50 | 4.2 | 3.2 |
| TCA118A1RDNP | 5.10 | 4.10 | 3.00 | 2.8 | 2.0 |
| TCA119T1BKNP | 5.10 | 4.10 | 3.00 | 2.8 | 2.0 |
| TCA120A1PKNP | 5.80 | 4.20 | 2.40 | 4.3 | 3.0 |
| TCA121A1PKNP | 5.80 | 4.20 | 2.50 | 5.7 | 4.7 |
| TCA122A1RDNP | 6.00 | 4.20 | 2.50 | 3.5 | 2.5 |
| TCA123A1WTNP | 5.50 | 4.20 | 2.20 | 7.6 | 6.0 |
| TCA124A1GPNP | 5.90 | 4.20 | 2.60 | 4.2 | 3.0 |
| TCA125A1RDNP | 6.00 | 4.20 | 2.40 | 4.3 | 3.3 |
| TCA126A1RDNP | 5.50 | 4.20 | 1.80 | 2.8 | 1.8 |
| TCA127T1BKNP | 6.00 | 4.20 | 2.50 | 3.5 | 2.5 |
| TCA128T1YWNP | 6.00 | 4.20 | 2.50 | 3.5 | 2.5 |
| TCA129T1BKNP | 5.90 | 4.20 | 2.00 | 4.0 | 3.0 |
| TCA130A1GPNP | 5.90 | 4.30 | 2.00 | 9.0 | 7.0 |
| TCA131A1PKNP | 6.00 | 4.30 | 2.00 | 9.4 | 8.0 |
| TCA132A1RDNP | 6.00 | 4.30 | 2.00 | 7.5 | 6.2 |
| TCA133T1BKNP | 5.80 | 4.30 | 2.50 | 4.4 | 3.1 |
| TCA134A1GPNP | 5.80 | 4.35 | 2.50 | 4.5 | 3.2 |
| TCA135A1WTNP | 6.00 | 4.50 | 2.00 | 4.5 | 3.0 |
| TCA136A1WTNP | 6.80 | 4.50 | 3.30 | 8.1 | 6.6 |
| TCA137A1WTNP | 5.50 | 4.50 | 2.50 | 5.2 | 4.2 |
| TCA138A1RDNP | 5.60 | 4.50 | 2.30 | 5.0 | 3.9 |
| TCA139T1BKNP | 6.00 | 4.50 | 2.00 | 4.0 | 3.0 |
| TCA140A1PKNP | 6.30 | 4.55 | 2.20 | 17.5 | 16.2 |
| TCA141A1PKNP | 6.50 | 4.60 | 3.30 | 8.1 | 6.5 |
| TCA142A1PKNP | 6.00 | 4.60 | 2.50 | 4.5 | 3.4 |
| TCA143A1PKNP | 6.50 | 4.70 | 3.00 | 3.5 | 2.0 |
| TCA144A1PKNP | 6.50 | 4.80 | 3.30 | 4.5 | 3.0 |
| TCA145A1GPNP | 6.50 | 4.80 | 3.30 | 6.5 | 5.0 |
| TCA146A1GPNP | 6.50 | 4.80 | 3.30 | 3.5 | 2.0 |
| TCA147A1RDNP | 6.80 | 4.80 | 3.00 | 2.4 | 1.3 |
| TCA148A1GPNP | 6.50 | 4.80 | 2.30 | 5.6 | 4.0 |
| TCA149A1PKNP | 6.80 | 4.80 | 3.00 | 6.5 | 5.5 |
| TCA150A1WTNP | 6.20 | 4.80 | 2.90 | 6.2 | 5.0 |
| TCA151T1BKNP | 6.80 | 4.80 | 3.30 | 5.4 | 4.0 |
| TCA152T1BKNP | 6.80 | 4.80 | 3.30 | 5.4 | 4.0 |
| TCA153A1PKNP | 6.40 | 4.85 | 2.50 | 5.2 | 3.6 |
| TCA154A1RDNP | 6.50 | 4.90 | 3.40 | 4.6 | 3.1 |
| TCA155A1PKNP | 9.00 | 5.00 | 3.50 | 4.0 | 2.8 |
| TCA156A1WTNP | 6.90 | 5.00 | 3.10 | 6.0 | 4.5 |
| TCA157A1PKNP | 6.50 | 5.00 | 3.20 | 3.2 | 2.2 |
| TCA158A1WTNP | 7.00 | 5.00 | 3.00 | 6.8 | 5.3 |
| TCA159A1PKNP | 8.00 | 5.00 | 3.00 | 11.0 | 6.0 |
| TCA160A1PKNP | 8.00 | 5.00 | 3.00 | 7.0 | 5.0 |
| TCA161A1WTNP | 7.50 | 5.00 | 3.00 | 5.0 | 4.0 |
| TCA162A1PKNP | 6.00 | 5.00 | 2.80 | 3.1 | 2.3 |

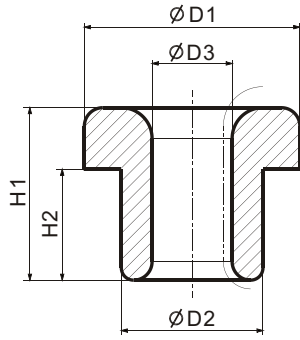

| Part No | D1 | D2 | D3 | H1 | H2 |
|--------------|-------|------|------|------|------|
| TCA163A1PKNP | 6.60 | 5.00 | 2.00 | 4.6 | 3.0 |
| TCA164A1WTNP | 7.00 | 5.00 | 2.90 | 6.9 | 4.6 |
| TCA165A1PKNP | 7.00 | 5.00 | 2.50 | 8.0 | 6.5 |
| TCA166A1GPNP | 7.50 | 5.00 | 3.00 | 5.0 | 4.0 |
| TCA167A1WTNP | 6.60 | 5.00 | 1.00 | 3.5 | 2.5 |
| TCA168A1PKNP | 6.90 | 5.00 | 3.30 | 5.5 | 4.0 |
| TCA169A1PKNP | 7.00 | 5.00 | 4.00 | 4.0 | 3.0 |
| TCA170A1PKNP | 6.40 | 5.00 | 3.00 | 4.0 | 3.0 |
| TCA171A1WTNP | 6.40 | 5.00 | 3.00 | 4.0 | 3.0 |
| TCA172A1GPNP | 6.50 | 5.00 | 3.50 | 3.5 | 2.0 |
| TCA173A1PKNP | 7.00 | 5.00 | 2.00 | 10.0 | 4.7 |
| TCA174A1GPNP | 6.60 | 5.00 | 2.00 | 8.0 | 6.5 |
| TCA175A1PKNP | 7.00 | 5.00 | 2.00 | 10.0 | 8.3 |
| TCA176A2LPRP | 7.00 | 5.00 | 3.00 | 6.8 | 5.3 |
| TCA177A1GPNP | 6.80 | 5.10 | 3.30 | 5.5 | 4.0 |
| TCA178A1PKNP | 6.80 | 5.10 | 3.30 | 7.0 | 5.0 |
| TCA179A1WTNP | 7.80 | 5.20 | 3.00 | 5.3 | 3.8 |
| TCA180A1PKNP | 7.80 | 5.20 | 3.00 | 6.3 | 4.8 |
| TCA181A1PKNP | 7.20 | 5.20 | 3.90 | 5.2 | 3.1 |
| TCA182A1PKNP | 6.80 | 5.30 | 3.30 | 5.3 | 4.1 |
| TCA183A1WTNP | 7.30 | 5.30 | 3.20 | 7.4 | 5.0 |
| TCA184A1RDNP | 7.00 | 5.40 | 3.20 | 9.7 | 7.9 |
| TCA185A1WTNP | 8.00 | 5.50 | 2.50 | 5.5 | 4.0 |
| TCA186A1PKNP | 8.00 | 5.50 | 3.50 | 4.0 | 3.0 |
| TCA187A1RDNP | 9.80 | 5.60 | 3.60 | 10.0 | 6.0 |
| TCA188A1WTNP | 7.90 | 5.60 | 3.10 | 6.4 | 5.1 |
| TCA189A1RDNP | 7.30 | 5.60 | 3.50 | 14.3 | 12.2 |
| TCA190A1GPNP | 7.90 | 5.60 | 3.20 | 9.1 | 6.9 |
| TCA191A1PKNP | 7.80 | 5.70 | 3.70 | 5.9 | 4.6 |
| TCA192T1BKNP | 7.60 | 5.70 | 3.30 | 5.8 | 4.0 |
| TCA193T1BKNP | 7.70 | 5.70 | 2.80 | 8.2 | 6.0 |
| TCA194A1WTNP | 7.70 | 5.80 | 3.00 | 5.8 | 4.0 |
| TCA195A1GPNP | 7.80 | 5.80 | 3.20 | 6.0 | 4.5 |
| TCA196A1RDNP | 7.70 | 5.80 | 3.00 | 5.9 | 4.0 |
| TCA197A1WTNP | 7.80 | 5.80 | 2.90 | 6.0 | 4.0 |
| TCA198A1PKNP | 7.80 | 5.80 | 2.90 | 7.7 | 6.0 |
| TCA199A1GPNP | 7.80 | 5.80 | 3.70 | 4.5 | 3.5 |
| TCA200A1RDNP | 7.80 | 5.80 | 2.90 | 7.7 | 5.7 |
| TCA201A1GPNP | 10.00 | 5.80 | 3.00 | 8.0 | 6.0 |
| TCA202A1RDNP | 9.20 | 5.80 | 3.00 | 6.4 | 4.2 |

| Part No | D1 | D2 | D3 | H1 | H2 |
|--------------|-------|------|------|------|------|
| TCA203T1BKNP | 7.80 | 5.80 | 3.70 | 4.5 | 3.5 |
| TCA204T1BKNP | 10.00 | 5.80 | 3.40 | 9.2 | 5.0 |
| TCA205T1YWNP | 10.00 | 5.80 | 3.40 | 9.2 | 5.0 |
| TCA206A1GPNP | 8.00 | 5.90 | 3.50 | 5.0 | 3.0 |
| TCA207A1PKNP | 8.00 | 5.90 | 3.50 | 5.0 | 3.0 |
| TCA208A1PKNP | 7.90 | 5.90 | 3.40 | 6.1 | 4.9 |
| TCA209A1GPNP | 7.80 | 5.90 | 3.40 | 4.8 | 4.0 |
| TCA210A1GPNP | 7.80 | 5.90 | 3.40 | 8.0 | 6.4 |
| TCA211A1WTNP | 7.90 | 5.90 | 3.40 | 6.6 | 4.9 |
| TCA212A1GPNP | 8.00 | 5.90 | 3.20 | 5.0 | 3.0 |
| TCA213A1WTNP | 7.90 | 5.90 | 3.40 | 6.4 | 5.0 |
| TCA214A1RDNP | 7.80 | 5.90 | 3.40 | 6.0 | 4.0 |
| TCA215A1GPNP | 7.70 | 5.90 | 4.20 | 3.2 | 1.8 |
| TCA216A1GPNP | 7.80 | 5.90 | 3.50 | 6.1 | 4.0 |
| TCA217A1GPNP | 7.80 | 5.90 | 3.40 | 6.5 | 5.0 |
| TCA218T1BKNP | 7.90 | 5.90 | 3.40 | 6.1 | 4.9 |
| TCA219T1BKNP | 7.80 | 5.90 | 3.40 | 8.0 | 6.4 |
| TCA220T1BKNP | 7.70 | 5.90 | 3.30 | 6.0 | 4.0 |
| TCA221T1BKNP | 8.00 | 5.90 | 3.20 | 5.0 | 3.0 |
| TCA222T1YWNP | 8.00 | 5.90 | 3.20 | 5.0 | 3.0 |
| TCA223T1BKNP | 7.80 | 5.90 | 3.40 | 6.0 | 4.0 |
| TCA224T1BKNP | 8.00 | 5.90 | 3.20 | 4.0 | 2.0 |
| TCA225T1BKNP | 7.80 | 5.90 | 3.40 | 12.0 | 10.0 |
| TCA226T1BKNP | 7.80 | 5.90 | 3.40 | 6.0 | 3.9 |
| TCA227A3WTRP | 8.00 | 5.90 | 3.50 | 5.8 | 4.0 |
| TCA228T1BKNP | 7.90 | 5.95 | 3.40 | 6.0 | 4.0 |
| TCA229A1PKNP | 9.00 | 6.00 | 4.00 | 8.0 | 6.5 |
| TCA230A1GPNP | 8.00 | 6.00 | 3.00 | 6.0 | 4.0 |
| TCA231A1WTNP | 7.50 | 6.00 | 3.00 | 8.6 | 7.6 |
| TCA232A1WTNP | 7.80 | 6.00 | 3.50 | 6.0 | 5.0 |
| TCA233A1PKNP | 7.60 | 6.00 | 3.20 | 5.7 | 4.1 |
| TCA234A1GPNP | 7.50 | 6.00 | 3.50 | 5.1 | 4.0 |
| TCA235A1PKNP | 8.35 | 6.00 | 3.95 | 8.1 | 6.5 |
| TCA236A1GPNP | 7.70 | 6.00 | 3.20 | 6.0 | 4.0 |
| TCA237A1WTNP | 8.40 | 6.00 | 4.10 | 4.6 | 3.1 |
| TCA238A1GPNP | 7.50 | 6.00 | 3.50 | 2.7 | 1.7 |
| TCA239A1GPNP | 7.80 | 6.00 | 3.40 | 8.0 | 6.4 |
| TCA240A1WTNP | 8.00 | 6.00 | 3.00 | 4.5 | 3.5 |
| TCA241A1RDNP | 10.40 | 6.00 | 3.00 | 18.8 | 15.8 |
| TCA242A1PKNP | 8.00 | 6.00 | 4.00 | 4.0 | 3.0 |
| TCA243A1PKNP | 7.00 | 6.00 | 3.50 | 6.0 | 5.0 |
| TCA244A1PKNP | 8.00 | 6.00 | 3.40 | 3.5 | 2.0 |
| TCA245A1PKNP | 11.80 | 6.00 | 4.00 | 7.8 | 5.7 |
| TCA246A1WTNP | 7.30 | 6.00 | 3.00 | 15.0 | 13.5 |
| TCA247T1BKNP | 8.40 | 6.00 | 4.10 | 4.6 | 3.1 |
| TCA248T1BKNP | 8.00 | 6.00 | 3.60 | 7.0 | 5.0 |
| TCA249T1BKNP | 7.50 | 6.00 | 3.40 | 8.0 | 6.5 |
| TCA250T1BKNP | 8.00 | 6.00 | 3.40 | 3.5 | 2.0 |

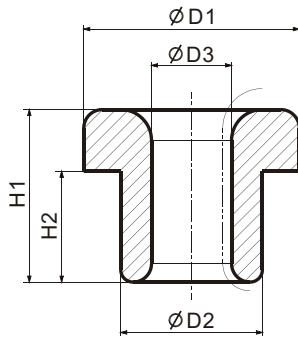

| Part No | D1 | D2 | D3 | H1 | H2 |
|--------------|-------|------|------|------|------|
| TCA251T1BKNP | 8.40 | 6.00 | 4.00 | 8.0 | 6.6 |
| TCA252T1BKNP | 10.00 | 6.05 | 3.00 | 6.4 | 4.4 |
| TCA253A1PKNP | 8.30 | 6.10 | 3.40 | 7.0 | 5.0 |
| TCA254A1PKNP | 8.30 | 6.10 | 3.40 | 7.0 | 5.0 |
| TCA255T1BKNP | 8.30 | 6.10 | 3.40 | 7.0 | 5.0 |
| TCA256A1WTNP | 7.40 | 6.20 | 3.60 | 16.8 | 15.3 |
| TCA257A1PKNP | 8.10 | 6.20 | 3.50 | 7.0 | 5.0 |
| TCA258A1GPNP | 10.20 | 6.20 | 4.10 | 10.0 | 8.0 |
| TCA259A1WTNP | 9.50 | 6.20 | 4.00 | 9.4 | 6.5 |
| TCA260A1PKNP | 8.80 | 6.20 | 4.00 | 3.5 | 2.5 |
| TCA261A1PKNP | 8.10 | 6.20 | 3.40 | 4.4 | 3.4 |
| TCA262T1BKNP | 8.40 | 6.20 | 3.80 | 4.5 | 3.1 |
| TCA263A1PKNP | 7.80 | 6.25 | 3.30 | 2.7 | 1.7 |
| TCA264A1WTNP | 7.80 | 6.25 | 3.40 | 16.5 | 15.2 |
| TCA265A3WTNP | 8.10 | 6.25 | 3.50 | 3.1 | 1.9 |
| TCA266A1WTNP | 8.50 | 6.30 | 4.00 | 8.2 | 6.6 |
| TCA267A1PKNP | 8.00 | 6.30 | 3.50 | 4.5 | 3.5 |
| TCA268A1PKNP | 10.60 | 6.30 | 2.90 | 10.4 | 8.4 |
| TCA269A1PKNP | 8.40 | 6.30 | 4.00 | 8.1 | 6.6 |
| TCA270A1PKNP | 8.10 | 6.30 | 3.40 | 6.3 | 4.2 |
| TCA271A1RDNP | 8.20 | 6.30 | 4.20 | 6.0 | 5.0 |
| TCA272T1BKNP | 10.60 | 6.30 | 2.90 | 10.4 | 8.4 |
| TCA273T1BKNP | 9.70 | 6.30 | 4.00 | 20.0 | 18.0 |
| TCA274A1WTNP | 7.80 | 6.40 | 3.60 | 4.9 | 3.4 |
| TCA275A1PKNP | 8.10 | 6.40 | 3.30 | 5.0 | 3.5 |
| TCA276A1GPNP | 8.70 | 6.40 | 4.00 | 4.6 | 3.2 |
| TCA277A1RDNP | 10.90 | 6.40 | 2.90 | 19.0 | 16.0 |
| TCA278A1RDNP | 10.90 | 6.40 | 2.90 | 16.0 | 13.0 |
| TCA279A1WTNP | 9.80 | 6.40 | 3.40 | 6.9 | 4.9 |
| TCA280T1BKNP | 8.70 | 6.40 | 4.00 | 4.6 | 3.2 |
| TCA281A1WTNP | 9.80 | 6.50 | 3.50 | 7.0 | 5.0 |
| TCA282A1PKNP | 9.00 | 6.50 | 3.00 | 8.0 | 6.0 |
| TCA283A1RDNP | 8.50 | 6.50 | 3.50 | 5.0 | 2.5 |
| TCA284A1PKNP | 8.00 | 6.50 | 4.00 | 4.0 | 3.0 |
| TCA285T1YWNP | 8.80 | 6.50 | 3.90 | 3.4 | 2.4 |
| TCA286A1WTNP | 8.80 | 6.60 | 3.80 | 7.4 | 5.9 |
| TCA287A1WTNP | 8.00 | 6.60 | 3.50 | 5.0 | 3.5 |
| TCA288A1RDNP | 8.80 | 6.60 | 3.70 | 7.5 | 5.9 |
| TCA289A1RDNP | 8.80 | 6.60 | 3.70 | 7.5 | 5.9 |
| TCA290A1WTNP | 8.80 | 6.60 | 3.80 | 7.5 | 5.9 |

| Part No | D1 | D2 | D3 | H1 | H2 |
|--------------|-------|------|------|------|------|
| TCA291A1PKNP | 8.70 | 6.60 | 3.80 | 7.5 | 6.0 |
| TCA292A1PKNP | 10.80 | 6.60 | 4.60 | 8.0 | 6.4 |
| TCA293A1WTNP | 9.00 | 6.60 | 4.00 | 9.0 | 6.0 |
| TCA294A1RDNP | 10.00 | 6.60 | 2.90 | 8.0 | 5.0 |
| TCA295A1PKNP | 10.00 | 6.70 | 4.00 | 9.2 | 7.2 |
| TCA296A1WTNP | 10.00 | 6.70 | 4.00 | 9.2 | 7.2 |
| TCA297A1PKNP | 8.70 | 6.70 | 3.80 | 4.8 | 3.0 |
| TCA298A1WTNP | 14.80 | 6.70 | 4.90 | 9.2 | 6.7 |
| TCA299A1GPNP | 8.80 | 6.70 | 3.80 | 6.1 | 4.0 |
| TCA300A1RDNP | 14.70 | 6.70 | 4.40 | 23.0 | 20.0 |
| TCA301A1WTNP | 10.00 | 6.80 | 4.00 | 10.0 | 8.0 |
| TCA302A1GPNP | 11.90 | 6.80 | 3.70 | 7.5 | 4.7 |
| TCA303A1RDNP | 9.90 | 6.80 | 5.00 | 8.0 | 6.8 |
| TCA304A1PKNP | 11.50 | 6.80 | 4.40 | 8.5 | 5.5 |
| TCA305A1PKNP | 9.00 | 6.80 | 4.30 | 8.6 | 7.6 |
| TCA306A1GPNP | 9.00 | 6.80 | 4.50 | 8.0 | 6.0 |
| TCA307A1RDNP | 14.80 | 6.80 | 4.90 | 8.3 | 5.8 |
| TCA308A1RDNP | 8.70 | 6.80 | 4.00 | 8.7 | 7.8 |
| TCA309A3WTRP | 11.60 | 6.80 | 3.80 | 7.2 | 4.7 |
| TCA310A1RDNP | 9.80 | 6.90 | 4.00 | 7.8 | 5.8 |
| TCA311A1GPNP | 10.00 | 6.90 | 5.00 | 3.2 | 2.0 |
| TCA312A1PKNP | 10.10 | 6.90 | 4.00 | 9.8 | 8.0 |
| TCA313A1PKNP | 9.10 | 6.90 | 4.50 | 7.8 | 5.8 |
| TCA314A1PKNP | 9.00 | 6.90 | 5.00 | 7.0 | 5.2 |
| TCA315A1GPNP | 10.20 | 6.90 | 4.00 | 12.1 | 10.2 |
| TCA316A1RDNP | 12.00 | 6.90 | 3.50 | 18.3 | 15.8 |
| TCA317A1PKNP | 8.00 | 6.90 | 3.50 | 5.0 | 3.5 |
| TCA318T1BKNP | 9.80 | 6.90 | 4.00 | 7.8 | 5.8 |
| TCA319A1PKNP | 9.80 | 6.95 | 5.00 | 7.8 | 6.6 |
| TCA320A1WTNP | 10.00 | 7.00 | 4.00 | 10.0 | 8.0 |
| TCA321A1PKNP | 8.00 | 7.00 | 5.00 | 5.0 | 3.5 |
| TCA322A1GPNP | 9.30 | 7.00 | 4.50 | 7.5 | 5.2 |
| TCA323A1PKNP | 9.00 | 7.00 | 4.00 | 7.0 | 5.0 |
| TCA324A1WTNP | 8.00 | 7.00 | 5.00 | 5.0 | 3.5 |
| TCA325A1WTNP | 8.80 | 7.00 | 4.50 | 5.5 | 4.2 |
| TCA326A1WTNP | 9.20 | 7.00 | 4.50 | 7.0 | 5.3 |
| TCA327A1PKNP | 12.00 | 7.00 | 3.50 | 5.0 | 3.0 |
| TCA328A1PKNP | 10.00 | 7.00 | 4.00 | 10.0 | 8.0 |
| TCA329A1PKNP | 9.30 | 7.00 | 4.50 | 9.3 | 7.0 |
| TCA330A1RDNP | 11.00 | 7.00 | 2.60 | 18.0 | 15.0 |
| TCA331A1GPNP | 9.80 | 7.00 | 4.90 | 8.6 | 6.8 |
| TCA332A1RDNP | 12.00 | 7.00 | 3.00 | 7.0 | 5.0 |
| TCA333A1GPNP | 8.00 | 7.00 | 5.00 | 5.0 | 3.5 |
| TCA334A1WTNP | 10.20 | 7.00 | 5.20 | 3.3 | 2.0 |
| TCA335A1PKNP | 9.10 | 7.00 | 4.20 | 7.0 | 5.3 |
| TCA336A2LPRP | 9.30 | 7.00 | 4.50 | 7.5 | 5.2 |
| TCA337A2LPRP | 12.00 | 7.00 | 3.50 | 5.0 | 3.0 |
| TCA338T1BKNP | 9.00 | 7.00 | 4.00 | 7.0 | 5.0 |

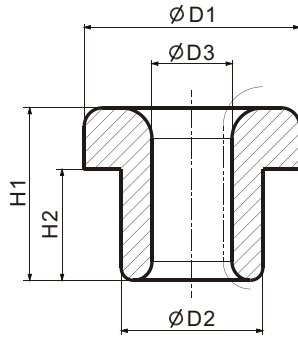

| Part No | D1 | D2 | D3 | H1 | H2 |
|--------------|-------|------|------|------|------|
| TCA339T1YWNP | 11.10 | 7.00 | 3.20 | 8.8 | 5.8 |
| TCA340T1BKNP | 10.00 | 7.00 | 4.00 | 10.0 | 8.0 |
| TCA341T1BKNP | 11.00 | 7.00 | 4.50 | 8.0 | 6.0 |
| TCA342T1YWNP | 12.00 | 7.00 | 4.50 | 5.0 | 2.5 |
| TCA343A3LPRP | 9.30 | 7.00 | 4.50 | 7.0 | 5.0 |
| TCA344A1PKNP | 9.20 | 7.10 | 2.80 | 5.0 | 3.0 |
| TCA345A1RDNP | 9.90 | 7.10 | 4.80 | 7.6 | 6.0 |
| TCA346T1BKNP | 9.90 | 7.10 | 4.80 | 7.5 | 5.8 |
| TCA347A1RDNP | 10.50 | 7.20 | 5.00 | 4.6 | 2.6 |
| TCA348A1PKNP | 10.00 | 7.20 | 3.50 | 8.0 | 6.0 |
| TCA349T1BKNP | 8.80 | 7.20 | 3.40 | 6.7 | 4.9 |
| TCA350A1PKNP | 10.00 | 7.25 | 4.80 | 3.0 | 1.5 |
| TCA351A1PKNP | 8.80 | 7.30 | 3.40 | 10.0 | 9.0 |
| TCA352A1GPNP | 9.50 | 7.30 | 3.90 | 9.0 | 7.0 |
| TCA353A1GPNP | 9.50 | 7.30 | 5.00 | 9.0 | 7.0 |
| TCA354A1PKNP | 9.90 | 7.30 | 3.20 | 4.5 | 3.5 |
| TCA355T1YWNP | 9.50 | 7.30 | 3.90 | 9.0 | 7.0 |
| TCA356T1YWNP | 10.00 | 7.30 | 3.60 | 3.5 | 2.2 |
| TCA357T1BKNP | 9.60 | 7.30 | 3.50 | 11.0 | 9.0 |
| TCA358A3WTRP | 13.70 | 7.30 | 4.80 | 9.0 | 6.7 |
| TCA359A1PKNP | 10.00 | 7.35 | 5.60 | 16.9 | 14.9 |
| TCA360A1PKNP | 9.50 | 7.40 | 3.90 | 8.0 | 6.0 |
| TCA361A1WTNP | 9.80 | 7.40 | 3.90 | 6.8 | 4.9 |
| TCA362A1GPNP | 9.50 | 7.40 | 5.40 | 13.5 | 11.5 |
| TCA363A1GPNP | 10.00 | 7.40 | 4.00 | 10.0 | 7.0 |
| TCA364T1YWNP | 9.80 | 7.40 | 3.90 | 6.8 | 4.9 |
| TCA365T1BKNP | 9.70 | 7.40 | 4.40 | 11.0 | 9.0 |
| TCA366A1PKNP | 9.70 | 7.50 | 4.40 | 11.0 | 9.0 |
| TCA367A1GPNP | 9.70 | 7.50 | 4.40 | 11.0 | 9.0 |
| TCA368A1WTNP | 10.00 | 7.50 | 4.00 | 8.0 | 5.0 |
| TCA369A1WTNP | 9.30 | 7.50 | 4.20 | 5.5 | 3.0 |
| TCA370A1PKNP | 8.00 | 7.50 | 5.00 | 2.5 | 1.5 |
| TCA371A1GPNP | 10.00 | 7.50 | 4.00 | 10.0 | 6.8 |
| TCA372A1RDNP | 10.00 | 7.50 | 3.90 | 10.0 | 7.0 |
| TCA373A1PKNP | 10.60 | 7.50 | 5.00 | 3.0 | 2.1 |
| TCA374T1BKNP | 10.00 | 7.50 | 4.00 | 8.0 | 5.0 |
| TCA375A3WTRP | 9.00 | 7.50 | 4.50 | 7.1 | 5.0 |
| TCA376A3WTRP | 12.00 | 7.50 | 3.50 | 8.5 | 3.5 |
| TCA377A1GPNP | 10.00 | 7.55 | 5.40 | 9.5 | 8.0 |
| TCA378A1PKNP | 10.70 | 7.60 | 4.80 | 6.5 | 4.5 |

| Part No | D1 | D2 | D3 | H1 | H2 |
|--------------|-------|------|------|------|------|
| TCA379T1BKNP | 9.60 | 7.70 | 5.40 | 9.9 | 8.0 |
| TCA380A1PKNP | 11.00 | 7.80 | 3.70 | 9.0 | 6.0 |
| TCA381A1RDNP | 9.60 | 7.80 | 6.00 | 4.0 | 3.0 |
| TCA382A1RDNP | 10.20 | 7.80 | 5.80 | 6.4 | 4.3 |
| TCA383A3WRPP | 11.00 | 7.80 | 4.00 | 7.0 | 5.0 |
| TCA384A1WTNP | 9.50 | 7.90 | 3.70 | 6.0 | 4.0 |
| TCA385A1RDNP | 10.00 | 7.90 | 4.00 | 7.0 | 5.0 |
| TCA386A1PKNP | 11.00 | 7.90 | 3.70 | 9.0 | 6.0 |
| TCA387A1WTNP | 10.00 | 7.90 | 4.50 | 7.0 | 5.0 |
| TCA388A1GPNP | 10.00 | 7.90 | 3.00 | 19.5 | 17.0 |
| TCA389T1BKNP | 10.00 | 7.90 | 3.00 | 19.5 | 17.0 |
| TCA390A1GPNP | 10.00 | 8.00 | 4.00 | 10.5 | 8.5 |
| TCA391A1PKNP | 11.00 | 8.00 | 3.60 | 9.0 | 6.0 |
| TCA392A1PKNP | 13.00 | 8.00 | 4.00 | 13.0 | 10.0 |
| TCA393A1PKNP | 10.00 | 8.00 | 4.10 | 8.3 | 6.4 |
| TCA394A1PKNP | 10.00 | 8.00 | 4.10 | 6.3 | 4.4 |
| TCA395A1WTNP | 10.00 | 8.00 | 4.50 | 7.2 | 5.0 |
| TCA396A1RDNP | 10.20 | 8.00 | 6.10 | 6.4 | 4.5 |
| TCA397A1PKNP | 12.80 | 8.00 | 2.00 | 8.0 | 5.4 |
| TCA398T1BKNP | 11.90 | 8.00 | 5.00 | 4.8 | 2.9 |
| TCA399A1GPNP | 9.30 | 8.05 | 5.00 | 11.5 | 9.5 |
| TCA400A1PKNP | 11.00 | 8.10 | 5.00 | 14.0 | 11.0 |
| TCA401A1PKNP | 10.00 | 8.10 | 4.60 | 21.0 | 17.7 |
| TCA402A1WTNP | 10.30 | 8.16 | 4.70 | 7.3 | 5.0 |
| TCA403A1WTNP | 10.30 | 8.16 | 4.70 | 7.3 | 5.0 |
| TCA404A1PKNP | 9.40 | 8.20 | 4.30 | 3.0 | 2.0 |
| TCA405A1WTNP | 10.30 | 8.20 | 4.70 | 7.3 | 5.0 |
| TCA406A1PKNP | 10.80 | 8.25 | 5.00 | 5.5 | 3.5 |
| TCA407A1PKNP | 10.00 | 8.30 | 4.00 | 7.0 | 5.4 |
| TCA408A1WTNP | 10.00 | 8.30 | 4.00 | 7.0 | 5.4 |
| TCA409A1RDNP | 11.00 | 8.30 | 5.00 | 8.0 | 6.0 |
| TCA410T1BKNP | 10.00 | 8.30 | 4.00 | 7.0 | 5.4 |
| TCA411T1BKNP | 12.50 | 8.30 | 5.00 | 16.0 | 14.0 |
| TCA412A1PKNP | 10.70 | 8.40 | 4.80 | 10.0 | 8.0 |
| TCA413T1BKNP | 10.70 | 8.40 | 4.80 | 6.0 | 4.0 |
| TCA414A1PKNP | 11.00 | 8.50 | 6.50 | 3.0 | 2.0 |
| TCA415T1BKNP | 10.70 | 8.50 | 4.80 | 8.0 | 6.0 |
| TCA416A1PKNP | 10.50 | 8.60 | 5.00 | 5.0 | 4.0 |
| TCA417A1GPNP | 10.70 | 8.60 | 4.80 | 8.0 | 6.0 |
| TCA418A1PKNP | 10.70 | 8.60 | 4.80 | 8.0 | 6.0 |
| TCA419A1PKNP | 10.70 | 8.60 | 4.80 | 14.0 | 12.0 |
| TCA420A1WTNP | 11.00 | 8.75 | 5.60 | 7.9 | 5.6 |
| TCA421A1WTNP | 11.60 | 8.80 | 5.60 | 8.9 | 6.8 |
| TCA422A1PKNP | 10.60 | 8.80 | 4.80 | 9.6 | 8.3 |
| TCA423A1GPNP | 10.60 | 8.80 | 4.80 | 12.8 | 11.3 |
| TCA424A1PKNP | 12.90 | 8.80 | 5.30 | 17.0 | 15.3 |
| TCA425A1GPNP | 10.70 | 8.80 | 4.90 | 7.2 | 5.0 |
| TCA426A1PKNP | 11.00 | 8.80 | 4.80 | 9.9 | 7.7 |

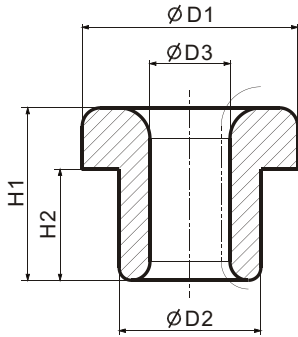

| Part No | D1 | D2 | D3 | H1 | H2 |
|---------------|-------|------|------|------|------|
| TCA427A1PKNP | 12.75 | 8.90 | 6.40 | 7.5 | 4.9 |
| TCA428A1RDNP | 13.20 | 8.90 | 4.20 | 7.0 | 4.9 |
| TCA429A1WTNP | 11.50 | 9.00 | 6.00 | 11.0 | 8.5 |
| TCA430A1WTNP | 11.50 | 9.00 | 5.50 | 9.0 | 7.0 |
| TCA431A1WTNP | 11.80 | 9.00 | 4.00 | 10.7 | 4.8 |
| TCA432A1GPNP | 11.00 | 9.00 | 6.00 | 5.0 | 3.0 |
| TCA433A1WTNP | 12.00 | 9.00 | 4.00 | 11.0 | 4.5 |
| TCA434A1PKNP | 12.70 | 9.00 | 5.30 | 7.0 | 5.0 |
| TCA435A1PKNP | 11.00 | 9.00 | 6.00 | 5.5 | 3.0 |
| TCA436A1RDNP | 10.70 | 9.00 | 6.00 | 7.2 | 5.2 |
| TCA437A1PKNP | 12.00 | 9.00 | 5.50 | 8.5 | 7.0 |
| TCA438A1WTNP | 10.90 | 9.00 | 6.00 | 5.8 | 3.3 |
| TCA439A1PKNP | 11.40 | 9.00 | 4.50 | 6.5 | 4.5 |
| TCA440A1PKNP | 12.00 | 9.00 | 3.00 | 11.0 | 4.5 |
| TCA441A1PKNP | 10.70 | 9.00 | 4.80 | 13.0 | 11.0 |
| TCA442T1BKNP | 11.50 | 9.00 | 6.70 | 9.1 | 6.0 |
| TCA443T1BKNP | 13.00 | 9.00 | 6.00 | 9.0 | 7.0 |
| TCA444T1YWNP | 13.00 | 9.00 | 6.00 | 9.0 | 7.0 |
| TCA445T1YWNP | 10.70 | 9.00 | 6.20 | 7.1 | 6.0 |
| TCA446A1WTNP | 10.80 | 9.05 | 6.10 | 7.2 | 5.0 |
| TCA447A1GPNP | 11.80 | 9.10 | 6.00 | 11.8 | 9.8 |
| TCA448A1WTNP | 10.80 | 9.10 | 6.00 | 6.2 | 3.5 |
| TCA449T1YWNP | 11.90 | 9.10 | 3.70 | 10.9 | 4.9 |
| TCA450A1PKNP | 12.00 | 9.20 | 5.30 | 10.0 | 7.0 |
| TCA451T1BKNP | 11.00 | 9.20 | 6.00 | 5.9 | 4.0 |
| TCA452T1YWNP | 11.00 | 9.20 | 6.00 | 5.9 | 4.0 |
| TCA453T1YWKNP | 11.00 | 9.20 | 4.60 | 7.1 | 5.0 |
| TCA454A1PKNP | 11.50 | 9.30 | 6.50 | 5.8 | 3.8 |
| TCA455A1GPNP | 11.90 | 9.30 | 6.00 | 10.6 | 8.2 |
| TCA456A1PKNP | 11.50 | 9.30 | 6.50 | 5.8 | 3.8 |
| TCA457A1WTNP | 12.50 | 9.30 | 4.70 | 9.4 | 6.3 |
| TCA458A1PKNP | 12.40 | 9.30 | 4.80 | 9.5 | 8.2 |
| TCA459A1WTNP | 12.00 | 9.40 | 6.20 | 7.9 | 5.5 |
| TCA460T1BKNP | 11.80 | 9.40 | 6.10 | 4.3 | 2.0 |
| TCA461T1BKNP | 11.60 | 9.40 | 6.60 | 5.7 | 3.8 |
| TCA462A1PKNP | 13.00 | 9.50 | 7.00 | 19.0 | 16.0 |
| TCA463A1GPNP | 12.00 | 9.50 | 6.20 | 9.0 | 7.0 |
| TCA464A1WTNP | 11.80 | 9.50 | 6.40 | 4.2 | 1.9 |
| TCA465A1PKNP | 11.00 | 9.50 | 6.50 | 6.5 | 5.0 |
| TCA466A1RDNP | 14.00 | 9.50 | 7.00 | 5.0 | 3.0 |

| Part No | D1 | D2 | D3 | H1 | H2 |
|--------------|-------|-------|------|------|------|
| TCA467A1GPNP | 13.00 | 9.50 | 5.00 | 9.5 | 6.5 |
| TCA468A2WTRP | 12.00 | 9.50 | 5.00 | 8.3 | 6.0 |
| TCA469A3WTRP | 12.00 | 9.50 | 5.00 | 8.3 | 6.0 |
| TCA470A3LPRP | 13.00 | 9.50 | 6.60 | 10.5 | 9.0 |
| TCA471A1WTNP | 11.80 | 9.60 | 6.40 | 4.2 | 1.9 |
| TCA472A1WTNP | 12.20 | 9.60 | 6.30 | 10.4 | 8.2 |
| TCA473A1WTNP | 12.00 | 9.60 | 6.20 | 4.8 | 2.4 |
| TCA474A1PKNP | 12.10 | 9.60 | 6.40 | 10.4 | 8.1 |
| TCA475A1PKNP | 12.00 | 9.60 | 6.20 | 4.6 | 2.5 |
| TCA476A1GPNP | 12.00 | 9.60 | 6.20 | 9.0 | 7.0 |
| TCA477A1PKNP | 13.30 | 9.60 | 6.60 | 17.7 | 14.3 |
| TCA478A1WTNP | 16.50 | 9.60 | 5.00 | 9.0 | 4.0 |
| TCA479A1PKNP | 13.00 | 9.60 | 4.50 | 19.0 | 16.0 |
| TCA480T1BKNP | 12.20 | 9.60 | 6.30 | 10.4 | 8.2 |
| TCA481T1BKNP | 15.40 | 9.60 | 3.80 | 10.6 | 7.7 |
| TCA482A1GPNP | 13.30 | 9.70 | 7.00 | 11.8 | 8.8 |
| TCA483A1WTNP | 12.20 | 9.70 | 5.00 | 9.6 | 6.5 |
| TCA484A1WTNP | 12.00 | 9.70 | 4.00 | 13.5 | 9.0 |
| TCA485A1WTNP | 12.00 | 9.70 | 5.90 | 12.4 | 7.4 |
| TCA486A1PKNP | 11.70 | 9.70 | 7.00 | 10.0 | 8.0 |
| TCA487A1RDNP | 15.00 | 9.73 | 5.60 | 33.5 | 28.6 |
| TCA488A3WTRP | 13.80 | 9.75 | 6.00 | 7.0 | 5.0 |
| TCA489A1GPNP | 12.10 | 9.80 | 6.10 | 15.0 | 11.0 |
| TCA490T1BKNP | 14.80 | 9.80 | 6.00 | 10.0 | 7.0 |
| TCA491T1YWNP | 14.80 | 9.80 | 6.00 | 10.0 | 7.0 |
| TCA492A1RDNP | 10.20 | 9.85 | 7.10 | 12.0 | 6.0 |
| TCA493A1PKNP | 14.70 | 9.85 | 5.30 | 25.0 | 21.9 |
| TCA494A1PKNP | 11.50 | 9.90 | 5.70 | 3.2 | 2.0 |
| TCA495A1PKNP | 13.50 | 9.90 | 6.30 | 16.5 | 13.0 |
| TCA496A1PKNP | 12.10 | 9.90 | 7.00 | 8.0 | 6.0 |
| TCA497A1GPNP | 12.10 | 9.90 | 7.00 | 11.0 | 9.0 |
| TCA498A1PKNP | 14.00 | 9.90 | 4.50 | 10.2 | 7.0 |
| TCA499A1WTNP | 14.00 | 9.90 | 4.50 | 10.2 | 7.0 |
| TCA500A1WTNP | 14.00 | 9.90 | 6.50 | 9.5 | 6.5 |
| TCA501A1RDNP | 12.20 | 9.90 | 7.00 | 6.0 | 4.0 |
| TCA502A1GPNP | 12.20 | 9.90 | 7.00 | 6.0 | 4.0 |
| TCA503A1WTNP | 14.00 | 9.90 | 6.50 | 9.6 | 6.6 |
| TCA504A1PKNP | 11.20 | 10.00 | 5.00 | 10.2 | 7.5 |
| TCA505A1GPNP | 13.00 | 10.00 | 7.20 | 12.0 | 9.2 |
| TCA506A1GPNP | 14.00 | 10.00 | 7.00 | 5.0 | 3.0 |
| TCA507A1PKNP | 14.00 | 10.00 | 7.00 | 7.0 | 4.0 |
| TCA508A1WTNP | 12.00 | 10.00 | 5.00 | 10.0 | 7.0 |
| TCA509A1WTNP | 11.00 | 10.00 | 6.40 | 6.0 | 5.0 |
| TCA510A1PKNP | 16.00 | 10.00 | 4.00 | 11.0 | 8.0 |
| TCA511A1PKNP | 12.00 | 10.00 | 4.90 | 8.5 | 7.0 |
| TCA512A1GPNP | 12.00 | 10.00 | 5.00 | 15.0 | 11.0 |
| TCA513A1PKNP | 14.00 | 10.00 | 6.50 | 12.0 | 9.6 |
| TCA514A1PKNP | 12.50 | 10.00 | 6.40 | 10.3 | 8.0 |

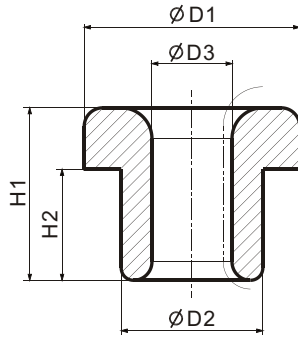

| Part No | D1 | D2 | D3 | H1 | H2 |
|--------------|-------|-------|------|------|------|
| TCA516A1WTNP | 14.00 | 10.00 | 2.00 | 11.0 | 5.0 |
| TCA517A1GPNP | 13.00 | 10.00 | 7.00 | 16.0 | 13.0 |
| TCA518A1WTNP | 13.00 | 10.00 | 5.00 | 9.0 | 5.5 |
| TCA519A1GPNP | 12.00 | 10.00 | 7.10 | 7.0 | 5.0 |
| TCA520A1GPNP | 12.00 | 10.00 | 6.00 | 15.0 | 11.0 |
| TCA521A1WTNP | 14.00 | 10.00 | 3.50 | 10.0 | 7.0 |
| TCA522A1PKNP | 12.20 | 10.00 | 5.00 | 13.0 | 8.7 |
| TCA523A1PKNP | 12.00 | 10.00 | 5.00 | 29.0 | 25.0 |
| TCA524A1RDNP | 11.20 | 10.00 | 6.60 | 6.2 | 5.1 |
| TCA525A1PKNP | 12.00 | 10.00 | 6.50 | 6.5 | 4.5 |
| TCA526A1RDNP | 12.00 | 10.00 | 6.00 | 8.0 | 6.0 |
| TCA527A1WTNP | 14.00 | 10.00 | 5.50 | 14.9 | 5.1 |
| TCA528A2WTRP | 14.00 | 10.00 | 3.50 | 10.0 | 7.0 |
| TCA529T1BKNP | 16.00 | 10.00 | 4.00 | 11.0 | 8.0 |
| TCA530T1BKNP | 13.50 | 10.00 | 7.00 | 13.0 | 10.2 |
| TCA531A3WTRP | 14.00 | 10.00 | 3.50 | 10.0 | 7.0 |
| TCA532A3WTRP | 13.00 | 10.00 | 4.90 | 8.5 | 4.9 |
| TCA533A3WTRP | 12.50 | 10.00 | 6.00 | 10.0 | 7.5 |
| TCA534A3WTRP | 12.00 | 10.00 | 6.00 | 7.0 | 5.0 |
| TCA535A1GPNP | 13.00 | 10.30 | 8.00 | 12.0 | 9.7 |
| TCA536A1GPNP | 14.20 | 10.50 | 7.00 | 18.2 | 15.5 |
| TCA537A1GPNP | 14.20 | 10.50 | 7.00 | 30.5 | 27.0 |
| TCA538A1PKNP | 14.00 | 10.50 | 6.20 | 25.5 | 22.5 |
| TCA539A1WTNP | 13.00 | 10.50 | 6.00 | 9.0 | 7.0 |
| TCA540A1PKNP | 14.20 | 10.50 | 7.00 | 29.5 | 27.0 |
| TCA541A1PKNP | 14.20 | 10.50 | 7.00 | 18.0 | 15.5 |
| TCA542A1PKNP | 14.20 | 10.50 | 7.00 | 20.5 | 18.0 |
| TCA543T1BKNP | 13.60 | 10.65 | 7.60 | 13.0 | 10.8 |
| TCA544A1WTNP | 14.40 | 10.75 | 6.60 | 25.0 | 21.0 |
| TCA545A1GPNP | 14.10 | 10.80 | 6.50 | 13.0 | 10.3 |
| TCA546A1PKNP | 14.00 | 10.90 | 3.10 | 10.5 | 7.5 |
| TCA547A1GPNP | 14.00 | 10.90 | 7.70 | 7.3 | 5.0 |
| TCA548A1GPNP | 14.00 | 10.95 | 7.70 | 6.5 | 5.0 |
| TCA549A1GPNP | 14.00 | 11.00 | 7.70 | 12.5 | 10.0 |
| TCA550A1PKNP | 14.00 | 11.00 | 8.00 | 9.0 | 6.0 |
| TCA551A1WTNP | 14.60 | 11.00 | 6.90 | 8.9 | 5.9 |
| TCA552A1GPNP | 13.00 | 11.00 | 7.00 | 6.5 | 5.0 |
| TCA553T1YWNP | 14.00 | 11.00 | 7.00 | 8.0 | 6.0 |
| TCA554A1GPNP | 14.00 | 11.30 | 7.00 | 9.0 | 7.0 |
| TCA555A1WTNP | 14.00 | 11.40 | 7.00 | 6.5 | 4.5 |

| Part No | D1 | D2 | D3 | H1 | H2 |
|--------------|-------|-------|-------|------|------|
| TCA556A1WTNP | 15.30 | 11.80 | 7.60 | 10.2 | 7.2 |
| TCA557A1WTNP | 15.40 | 11.80 | 7.60 | 10.2 | 7.0 |
| TCA558A1PKNP | 18.00 | 11.80 | 5.00 | 8.9 | 5.4 |
| TCA559A1PKNP | 26.10 | 11.80 | 7.60 | 11.6 | 8.8 |
| TCA560A1GPNP | 15.40 | 11.80 | 7.60 | 10.2 | 7.2 |
| TCA561A1PKNP | 15.40 | 11.80 | 7.60 | 10.2 | 7.2 |
| TCA562T1BKNP | 26.10 | 11.80 | 7.60 | 11.6 | 8.8 |
| TCA563A1PKNP | 15.40 | 11.90 | 7.60 | 6.5 | 4.5 |
| TCA564A1WTNP | 15.50 | 12.00 | 7.90 | 8.8 | 6.5 |
| TCA565A1WTNP | 15.00 | 12.00 | 8.00 | 9.0 | 7.0 |
| TCA566A1PKNP | 15.90 | 12.00 | 9.30 | 11.9 | 8.8 |
| TCA567A1RDNP | 16.00 | 12.00 | 6.00 | 15.0 | 12.5 |
| TCA568A1RDNP | 16.00 | 12.00 | 6.00 | 8.0 | 5.5 |
| TCA569T1BKNP | 14.00 | 12.00 | 6.00 | 6.0 | 4.0 |
| TCA570A1PKNP | 15.10 | 12.10 | 8.20 | 9.5 | 6.5 |
| TCA571A1PKNP | 15.00 | 12.20 | 7.10 | 6.2 | 4.0 |
| TCA572A1PKNP | 15.40 | 12.20 | 7.60 | 8.9 | 6.5 |
| TCA573T1YWNP | 15.70 | 12.30 | 6.80 | 8.9 | 6.5 |
| TCA574A1WTNP | 15.80 | 12.40 | 8.60 | 10.2 | 7.0 |
| TCA575A1PKNP | 15.00 | 12.40 | 8.70 | 15.0 | 12.5 |
| TCA576A1RDNP | 16.00 | 12.50 | 8.60 | 10.3 | 7.2 |
| TCA577A1GPNP | 15.90 | 12.50 | 8.70 | 10.2 | 7.2 |
| TCA578A1PKNP | 14.00 | 12.50 | 8.00 | 11.0 | 8.0 |
| TCA579A1GPNP | 15.00 | 12.50 | 7.00 | 6.0 | 4.0 |
| TCA580A1PKNP | 15.90 | 12.50 | 8.70 | 14.0 | 10.0 |
| TCA581A1PKNP | 16.50 | 12.50 | 7.50 | 19.0 | 16.0 |
| TCA582A1GPNP | 15.90 | 12.50 | 8.70 | 7.1 | 4.0 |
| TCA583A2WTRP | 15.00 | 12.50 | 7.00 | 6.0 | 4.0 |
| TCA584A3WTRP | 15.00 | 12.50 | 7.00 | 6.0 | 4.0 |
| TCA585A1PKNP | 15.70 | 12.60 | 4.60 | 7.0 | 4.0 |
| TCA586A1PKNP | 15.20 | 12.60 | 7.60 | 6.0 | 4.0 |
| TCA587T1BKDP | 17.90 | 12.60 | 8.70 | 10.3 | 7.1 |
| TCA588A1PKNP | 18.00 | 12.80 | 8.70 | 10.2 | 7.2 |
| TCA589A1PKNP | 18.00 | 12.80 | 8.70 | 14.0 | 10.0 |
| TCA590A1WTNP | 17.70 | 12.90 | 7.10 | 12.0 | 9.0 |
| TCA591A1WTNP | 18.00 | 13.00 | 7.00 | 11.2 | 8.2 |
| TCA592A1WTNP | 18.00 | 13.00 | 7.00 | 19.0 | 16.0 |
| TCA593A1GPNP | 16.00 | 13.00 | 8.50 | 11.0 | 8.0 |
| TCA594T1BKNP | 14.90 | 13.20 | 9.60 | 5.7 | 3.8 |
| TCA595A3LPRP | 20.00 | 13.30 | 8.50 | 8.0 | 5.0 |
| TCA596A1GPNP | 15.60 | 13.80 | 10.00 | 6.0 | 4.0 |
| TCA597T1BKNP | 15.60 | 13.80 | 10.00 | 6.0 | 4.0 |
| TCA598A1PKNP | 20.00 | 14.00 | 10.00 | 20.0 | 13.0 |
| TCA599A1PKNP | 18.00 | 14.00 | 9.00 | 7.0 | 5.0 |
| TCA600A1WTNP | 18.00 | 14.00 | 10.00 | 9.8 | 6.6 |
| TCA601A1GPNP | 16.10 | 14.00 | 10.00 | 6.1 | 3.8 |
| TCA602A2WTRP | 20.00 | 14.00 | 10.00 | 20.0 | 13.0 |
| TCA603A1WTNP | 17.80 | 14.50 | 10.50 | 26.0 | 23.0 |

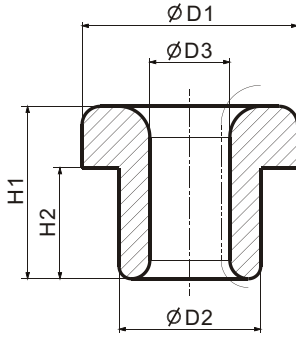

| Part No | D1 | D2 | D3 | H1 | H2 |
|--------------|-------|-------|-------|------|------|
| TCA604A1PKNP | 18.00 | 15.00 | 10.00 | 3.5 | 2.0 |
| TCA605A1PKNP | 18.00 | 15.00 | 9.80 | 13.0 | 10.5 |
| TCA606A1GPNP | 19.50 | 15.30 | 9.70 | 9.0 | 6.0 |
| TCA607A1GPNP | 19.60 | 15.30 | 10.00 | 13.8 | 10.0 |
| TCA608A3LPRP | 19.50 | 15.30 | 9.70 | 13.6 | 10.0 |
| TCA609A1GPNP | 19.70 | 15.40 | 10.00 | 8.3 | 5.1 |
| TCA610A1PKNP | 19.00 | 15.50 | 10.80 | 10.6 | 7.4 |
| TCA611A1GPNP | 20.00 | 16.00 | 11.00 | 12.0 | 8.0 |
| TCA612A1WTNP | 17.50 | 16.00 | 10.00 | 10.0 | 8.0 |
| TCA613A1PKNP | 21.00 | 16.00 | 10.00 | 9.0 | 6.0 |
| TCA614T1BKNP | 20.00 | 16.00 | 11.00 | 12.0 | 8.0 |
| TCA615A1PKNP | 21.50 | 16.20 | 12.20 | 5.2 | 3.2 |
| TCA616A1RDNP | 20.50 | 18.00 | 10.00 | 5.5 | 3.5 |
| TCA617A1PKNP | 20.00 | 18.00 | 12.00 | 5.0 | 4.0 |
| TCA618T1BKNP | 24.00 | 18.00 | 12.00 | 14.0 | 10.0 |

| Part No | D1 | D2 | D3 | H1 | H2 |
|--------------|-------|-------|-------|------|------|
| TCA619A1GPNP | 22.20 | 18.20 | 12.20 | 13.5 | 10.1 |
| TCA620A1PKNP | 23.00 | 18.50 | 14.00 | 8.0 | 6.0 |
| TCA621A3LPRP | 20.50 | 19.00 | 14.00 | 9.0 | 7.0 |
| TCA622A1GPNP | 25.70 | 19.60 | 4.00 | 12.5 | 9.3 |
| TCA623A1GPNP | 25.00 | 20.00 | 15.00 | 8.0 | 5.5 |
| TCA624A1GPNP | 25.00 | 20.00 | 15.00 | 18.0 | 15.5 |
| TCA625A1PKNP | 27.80 | 21.00 | 15.50 | 7.9 | 4.8 |
| TCA626T1BKNP | 27.00 | 21.00 | 15.00 | 14.0 | 10.0 |
| TCA627A1PKNP | 28.20 | 21.60 | 16.10 | 11.0 | 7.0 |
| TCA628A1PKNP | 28.30 | 22.00 | 3.20 | 14.0 | 9.0 |
| TCA629A1GPNP | 28.30 | 22.00 | 16.00 | 14.0 | 10.0 |
| TCA630A1GPNP | 28.00 | 22.00 | 13.00 | 14.0 | 9.0 |
| TCA631A1WTNP | 35.00 | 25.00 | 18.00 | 8.0 | 5.5 |
| TCA632A1PKNP | 31.50 | 25.70 | 20.00 | 8.0 | 6.0 |
| TCA633A1PKNP | 30.00 | 26.20 | 17.00 | 15.0 | 12.0 |
| TCA634A1GPNP | 32.00 | 27.00 | 22.00 | 12.0 | 9.5 |
| TCA635A1WTNP | 32.00 | 28.00 | 20.00 | 2.8 | 2.5 |
| TCA636A1RDNP | 35.00 | 30.00 | 20.00 | 25.0 | 22.0 |
| TCA637A1WTNP | 33.50 | 30.50 | 22.00 | 10.0 | 6.0 |
| TCA638A2WTRP | 33.50 | 30.50 | 22.00 | 10.0 | 6.0 |
| TCA639A1RDNP | 37.90 | 34.80 | 24.10 | 10.9 | 8.0 |
| TCA640A1PKNP | 44.00 | 40.50 | 30.00 | 10.0 | 7.0 |